

Rannila

Sisekarkass

Vaheseinte ja ripplagede
kanderaamistik

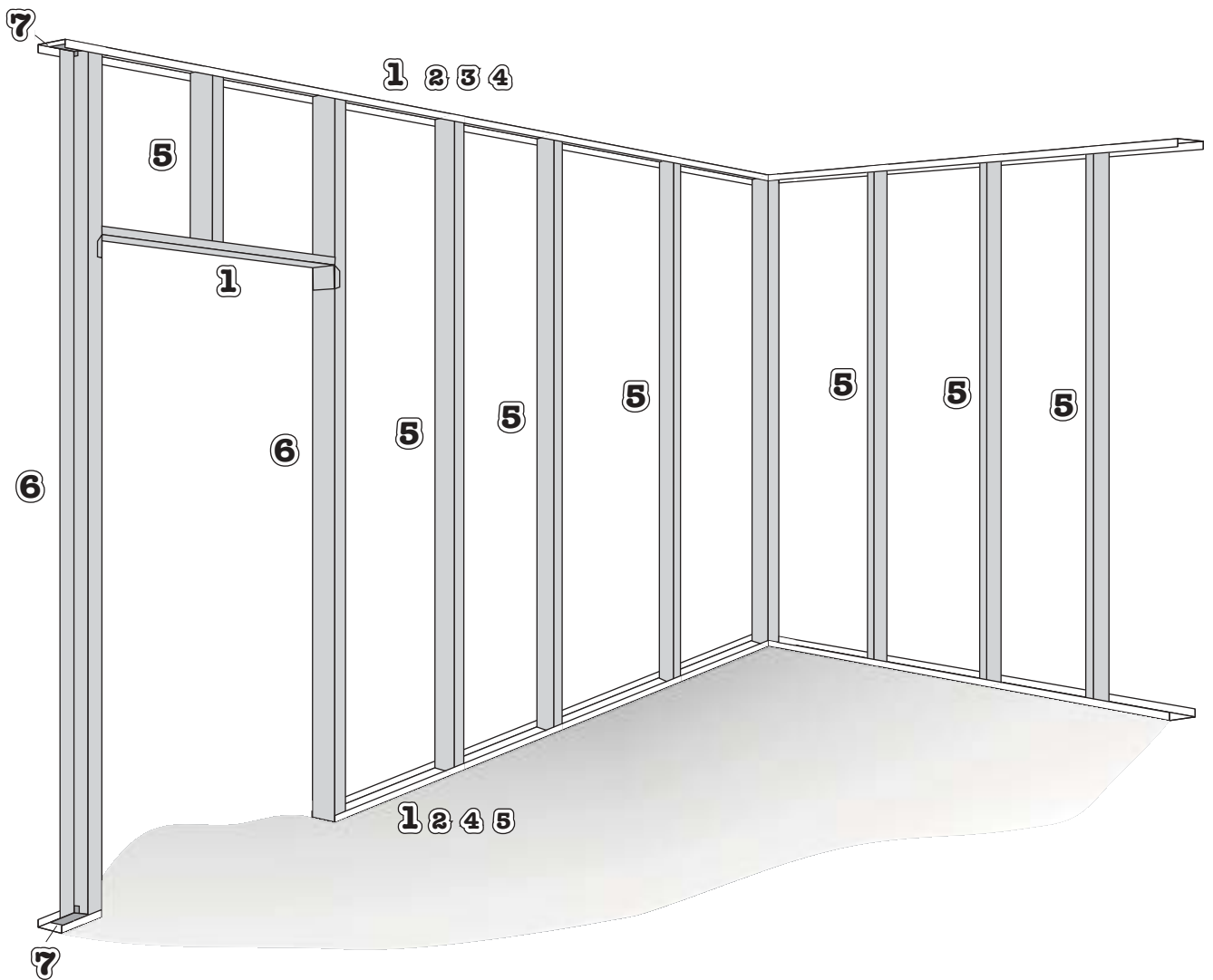

1 Põranda- ja laevööd SK

Pleki paksus 0,56 mm.

Serva kõrgus			
30 mm	37 mm	40 mm	60 mm
SK 42 / 30	SK 42 / 37	SK 50 / 40	SK 42 / 60
SK 66 / 30	SK 66 / 37	SK 75 / 40	SK 66 / 60
SK 70 / 30	SK 70 / 37	SK 100 / 40	SK 70 / 60
SK 95 / 30	SK 95 / 37		SK 95 / 60
SK 100 / 30	SK 100 / 37		SK 100 / 60
			SK 120 / 60
			SK 145 / 60
			SK 160 / 60

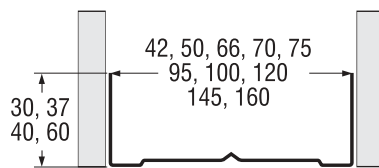

Lao pikkused 3000 ja 3100 mm.

2 Tihendiga põranda- ja laevööd SKF

Ebatasasele pinnale

Serva kõrgus		
37 mm	60 mm	
SKF 42 / 37	SKF 42 / 60	SKF 100 / 60
SKF 66 / 37	SKF 66 / 60	SKF 120 / 60
SKF 70 / 37	SKF 70 / 60	SKF 145 / 60
SKF 95 / 37	SKF 95 / 60	SKF 160 / 60
SKF 100 / 37		

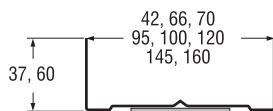

Kleepuv tihendlint

3 x 25, 3 x 40 ja 3 x 60 mm

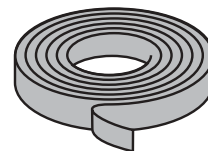

3 Heliisolatsioonitihendiga põranda- ja laevööd SKE

Serva kõrgus	
37 mm	60 mm
SKE 66 / 37	SKE 66 / 60
SKE 70 / 37	SKE 70 / 60
SKE 95 / 37	SKE 95 / 60

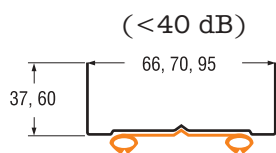

Heliisolatsioonilint EPDM

10 x 45 mm

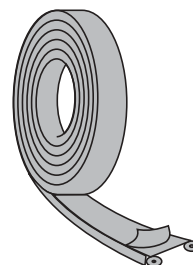

4 Heliisolatsioonitihendiga põranda- ja laevööd SKT

Serva kõrgus	
37 mm	60 mm
SKT 66 / 37	SKT 66 / 60
SKT 70 / 37	SKT 70 / 60
SKT 95 / 37	SKT 95 / 60

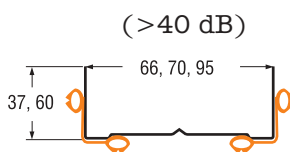

Eritellimisel tihendite liimimine tehase poolt kõikidele vöö tüüpidele.

5 Jätkatavad postid LPR ja LR

Pleki paksus 0,56 mm.

Serva kõrgus			
35 mm	40 mm	47 mm	
LPR 42 / 35	LPR 42 / 40	LPR 42 / 47	LPR 95 / 47
LPR 66 / 35	LPR 66 / 40	LPR 50 / 47	LPR 100 / 47
LPR 70 / 35	LPR 70 / 40	LPR 66 / 47	LR 120 / 47
LPR 95 / 35	LPR 95 / 40	LPR 70 / 47	LR 145 / 47
		LPR 75 / 47	LR 160 / 47

LPR
avadega post

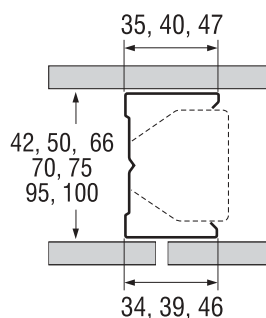

LR
avadeta post

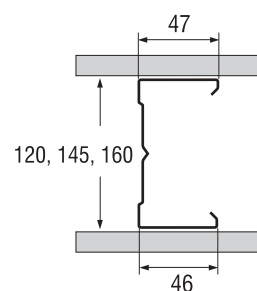

Lao pikkused 2600, 3000 ja 3300 mm,
valmistame poste pikkustega 2000 - 6000 mm.

6 Tugevduspostid FR avadele
Pleki paksus 1,00 mm.

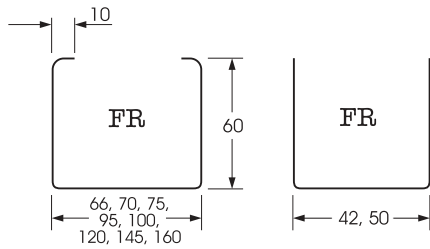

Tooted: FR 42, 50, 66, 70, 75, 95, 100, 120, 145, 160.

Lao pikkused 2600 ja 3000 mm.

7 Klamber FRK tugevduspostide
kinnitamiseks

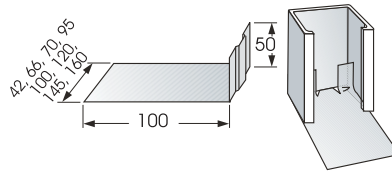

Tooted: FRK 42, 66, 70, 95, 100, 120, 145, 160.

8 Kinnitusdetail V
Karkassi vahetükk.

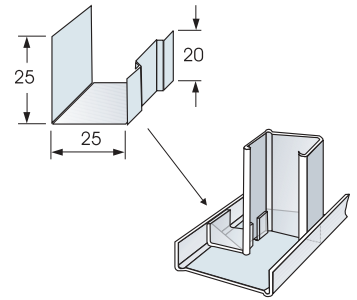

Tarvikud

Paindevaruliist PL 1

Teleskoopühenduse katteliist
Pleki paksus 0,70 mm

Vöö tähis	PL 1	
	1 kiht kipsiplaati	2 kihti kipsiplaati
SK 42/30, 42/37, 42/60	PL 68	PL 94
SK 50/40	PL 76	PL 102
SK 66/30, 66/37, 66/60	PL 92	PL 118
SK 70/30, 70/37, 70/60	PL 96	PL 122
SK 75/40	PL 101	PL 127
SK 95/30, 95/37, 95/60	PL 121	PL 147
SK 100/30, 100/37, 100/40, 100/60	PL 126	PL 152
SK 120/60	PL 146	PL 172
SK 145/60	PL 171	PL 197
SK 160/60	PL 186	PL 212

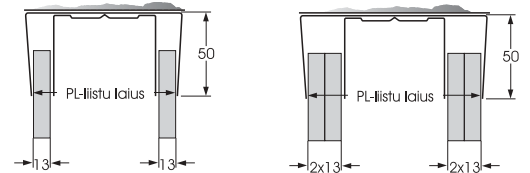

Lao pikkused 3000 ja 3100 mm.

Nurgapost HR 60/60

Sisenurkade ja T-ühenduste
tugipost.
Pleki paksus 0,56 mm.

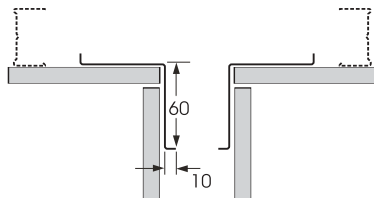

Lao pikkused 2600 ja 3000 mm.

Nurgaliist H 40/40, 50/50

Tugipost nurkades.
Pleki paksus 0,56 mm.

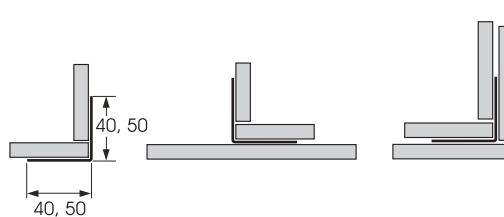

Lao pikkused 2600 ja 3000 mm.

Nurga katteliist HS 29/29

Kaitseb seina välisnurka.
Pleki paksus 0,56 mm.

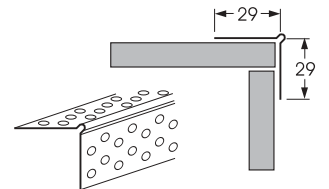

Lao pikkus 3100 mm.

Otsaliist J13, J26

Plaadi otste kaitseks.
Pleki paksus 0,56 mm

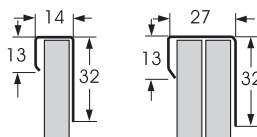

Lao pikkus 3000 mm.

Isolatsioonitugi IR 16

Isolatsioonimaterjali eraldamiseks katte-
plaatidest tuulduvas konstruktsioonis.
Pleki paksus 0,56 mm.

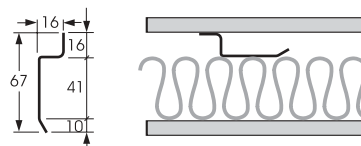

Lao pikkus 3100 mm.

Kinnitusliist S

Kasutatakse ripplagedel (PK)
ja seinte renoveerimisel.
Pleki paksus 0,56 mm.

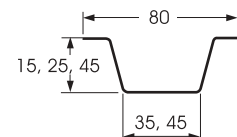

Tooted: S 15/80, 25/80, 45/80
Lao pikkused 2600, 3000 ja
3500 mm. Valmistame liiste
pikkustega 500 - 4000 (6000) mm.

Inventarialused

Materjal: 1,0 mm tsinkplekk.

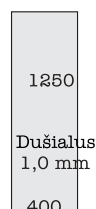
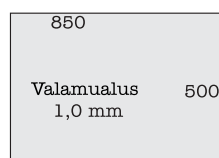

Ripplagede kandetalastik GK-süsteem

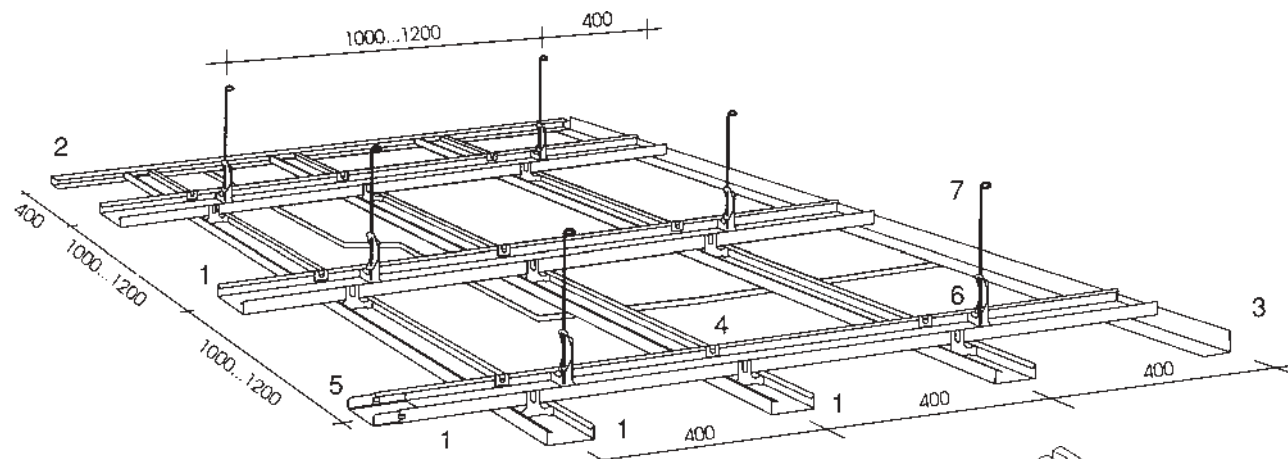

1 Kandetala GK-1.

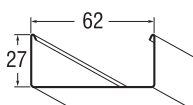

4 Kandur K-02.



5 Jätkutükk K-01.

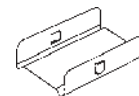

6 Lukustusklamber K-05.



7 Riputustraad RL 12.
l=100 ... 1100 mm



2 Servaliist GK-2.

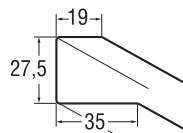

3 Nurgaliist H 50/50 (vt. tarvikud).

PK süsteem

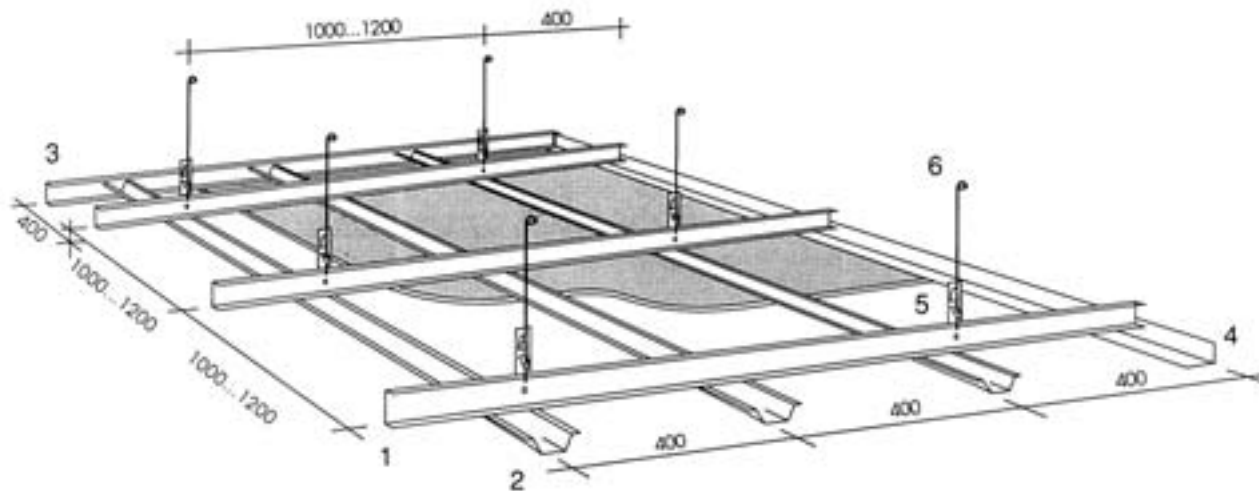

1 Peatala P-45.
Pleki paksus
1,00 mm.

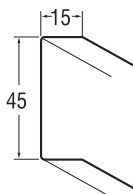

5, 6 Riputustraad RL 12 fiksaatoriga.



Riputuskõrgus l=100 - 1300 mm.

2 Kinnitusliist S 15/60, 22/80, 40/80 (vt. tarvikud).

3 Servaliist P-45 (vt. 1).

4 Nurgaliist H 50/50 (vt. tarvikud).

RL 12A	100 - 300 mm
RL 12B	300 - 500 mm
RL 12C	500 - 700 mm
RL 12D	700 - 900 mm
RL 12E	900 - 1100 mm
RL 12F	1100 - 1300 mm

Rannila
RAUTARUUKKI GROUP

AS Rannila Profiil

Turba 7 • Pärnu 80041 • EESTI
Tel. (044) 79900 • Faks (044) 79999
Internet www.rannilaprofiil.ee
E-mail info@rannila.ee

Tallinna kontor: Pärnu mnt 186, 11314 Tallinn, tel (0) 6 512 770, faks (0) 6 512 799
Tartu kontor: Ringtee 26, Tartu 51013, tel (07) 301 881, faks (07) 301 889
Jõhvi kontor: Jaama 14, Jõhvi 41533, tel (033) 707 06, faks (033) 707 05

